

Parts List		
ITEM	QTY	PART NUMBER
1	1	main tube tube
2	4	support tube
3	1	rear tube
6	1	main tube riser
7	1	main tube extention
8	1	kickstand
9	2	kickstand pivot
10	2	kickstand hanger
16	1	wheel riser
17	1	wheel mount
18	1	Fender

Wheel is a 4.8 x 8 trailer wheel.  
 Rear suspension started as northerntool # 224222  
 Northern tool part then had the arm cut and extended 4 inches, as well as flipping the spindle 180 deg.  
 When welding the arm backtogether use caution not to heat the rubber in the square tube.  
 The box I used is a Thule Side kick 682  
 I drilled the box and light mounting holes after building the frame.  
 No lights are shown, I used a set of LED lights I picked up at a local Tractor Supply store.  
 During build be sure to center tire and align with frame main tube.

To connect to bike I used a U joint from a tractor PTO.  
 The actual coupler to the bike is a UniGo coupler.  
 You can also get the U joint from UniGo but it costs more.

For wheels on the support stand I used rollerblade wheels.

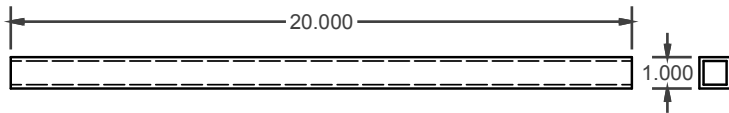
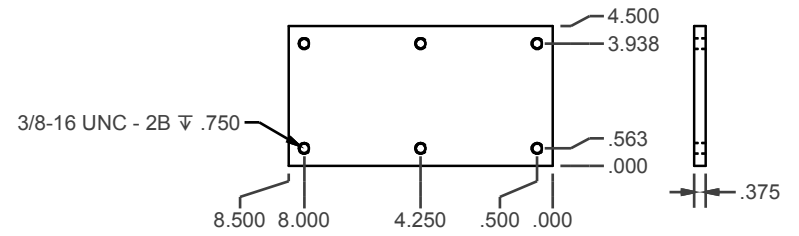
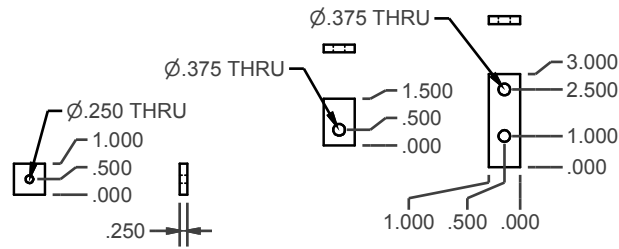
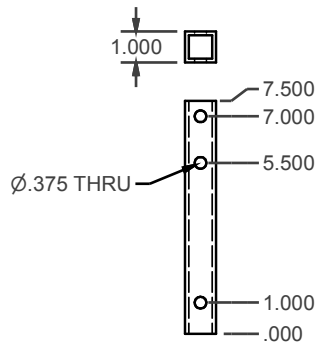
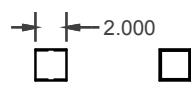
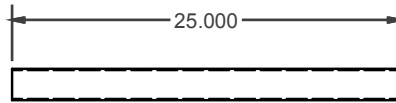
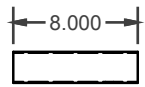
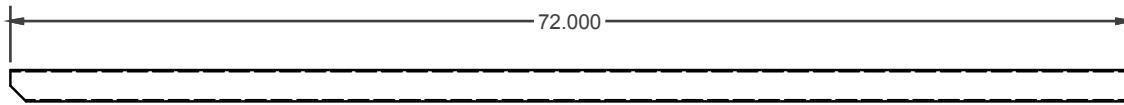

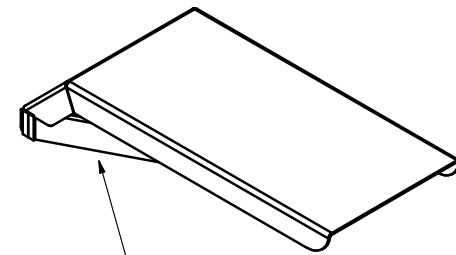
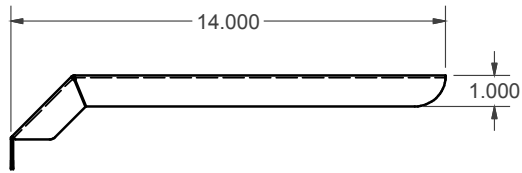

Fender supports are 1 X ¼ flat bar cut and fit by hand

